



# DRY COOLING

## Shanghai Electric-SPX Engineering & Technologies Co., Ltd.

2218 Yangshupu Road, Yangpu Dist., Shanghai, China | Suite 8F, Tower B, Gateway Plaza, No. 18 Xia Guang Li, North Road,  
Tel: +86 21 6070 3766 | East 3rd Ring, Chao Yang District, Beijing 100027 China  
Fax: +86 21 6070 3858 | Tel: +86 10 5608 2100 Fax: +86 10 5608 2130

Published on Mar. 2016

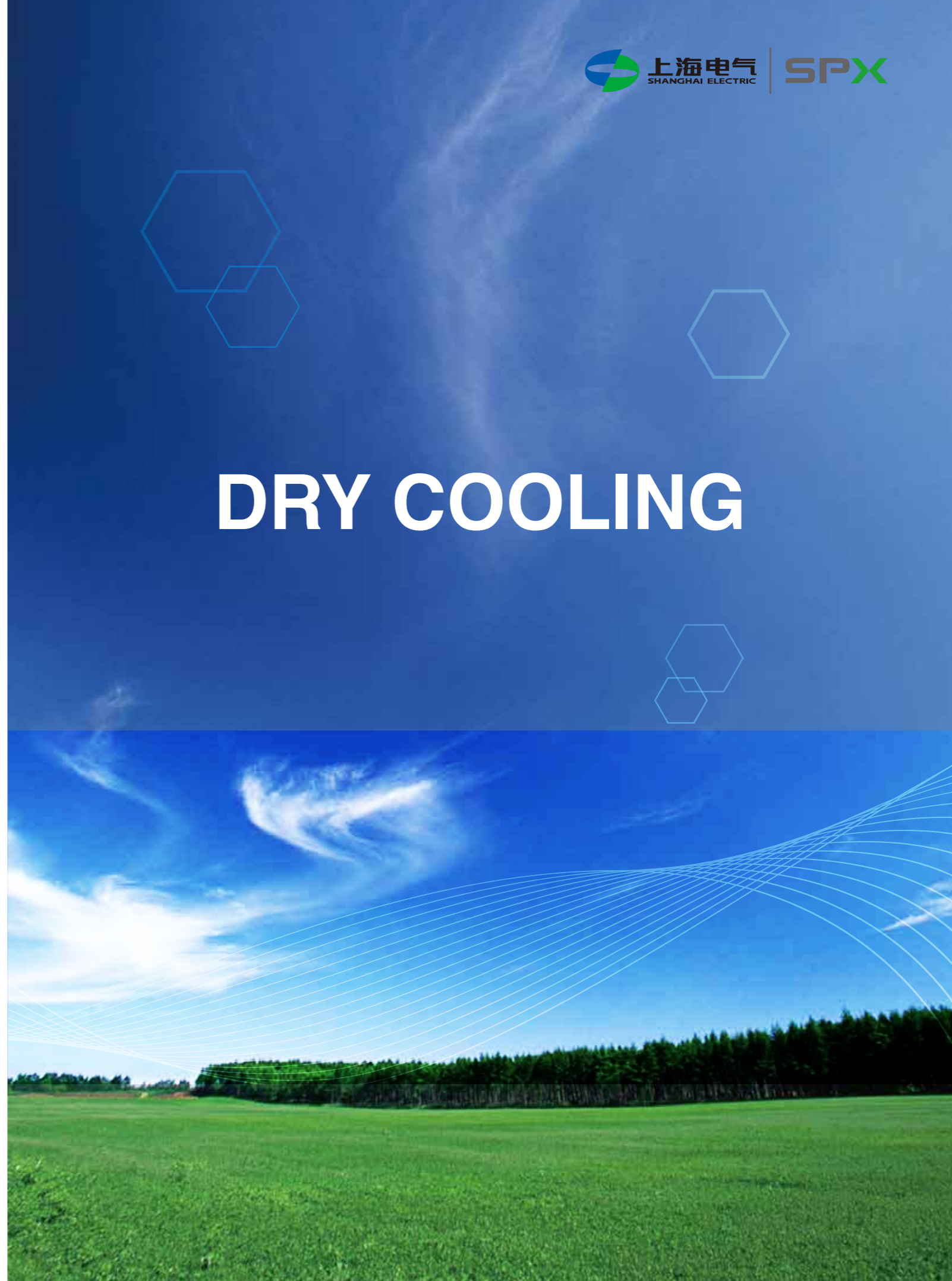

Shanghai Electric SPX Engineering & Technologies Co., Ltd (“SEC-SPX” for short) is a strategic joint venture between Shanghai Electric Group Co., Ltd and SPX Corporation. The company, formed in December 2011, is based in Shanghai with a branch office located in Beijing. SEC-SPX is dedicated to supplying advanced dry cooling systems, ESP/filter and moisture separator reheater (MSR) for power plants in China and select global opportunities. SEC-SPX has a registered capital of RMB 256 million. Shanghai Electric Group Co. Ltd owns 55% of the joint venture while SPX holds the remaining 45%.

Upon the establishment of SEC-SPX, SPX transfers all its dry cooling technologies and patents into the joint venture. Meanwhile, the joint venture houses an R&D center in Shanghai to be synchronized with the technology advancement developed by SPX’s European technology center. Thus SEC-SPX is equipped with the world-leading technology to provide products and services to customers in China and globally.

Leveraging power and energy market resources of Shanghai Electric in China and other emerging markets, as well as the technology advancement and project achievement of SPX in the global market, SEC-SPX focuses on innovation, research and development of dry cooling, ESP/filter and MSR technologies to become a leading supplier of quality products and services not only in China, but also globally.

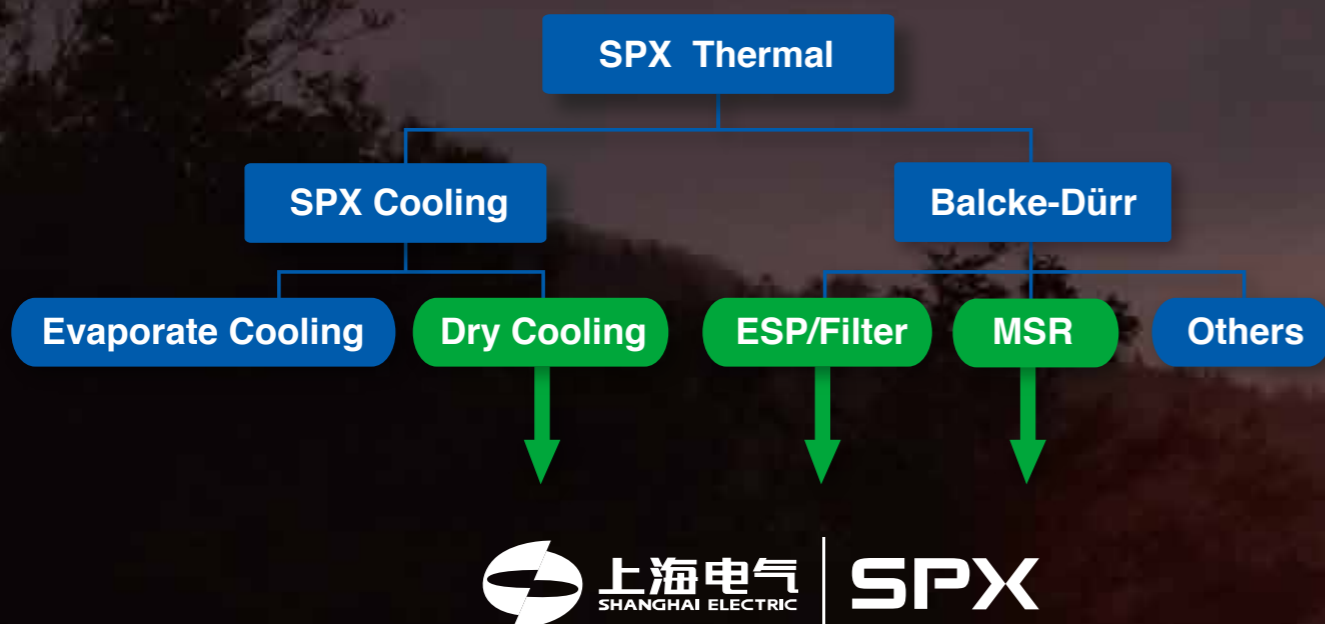

# CONTENTS

## Dry Cooling Products

### Origin of Dry Cooling Technologies

#### Mechanical Draft Air Cooled Condenser (ACC)

Characteristic technology ADVANCED ACC

Characteristic technology NDC

Advantages of SEC-SPX Air Cooled Condenser

#### Natural Draft Indirect Dry Cooling Tower (IDCT)

IDCT products

RAFT

MCT

Steel Tower

### Manufacturing Bases

### Achievements

# Dry Cooling Products

Dry cooling products are mainly used in drought areas as they can limit drastically water consumption. SEC-SPX's dry cooling products are applied to cool, directly or indirectly, exhaust steam from the turbine during power generation process.

Direct cooling products include: mechanical draft air cooled condenser (ACC: A-Frame or HEXACOOL) and natural draft air cooled condenser (NDC). Indirect cooling products include: mechanical draft indirect dry cooling system and natural draft indirect dry cooling tower (IDCT).



Mechanical Draft Air Cooled Condenser (ACC A-Frame)



Mechanical Draft Air Cooled Condenser (ACC HEXACOOL)

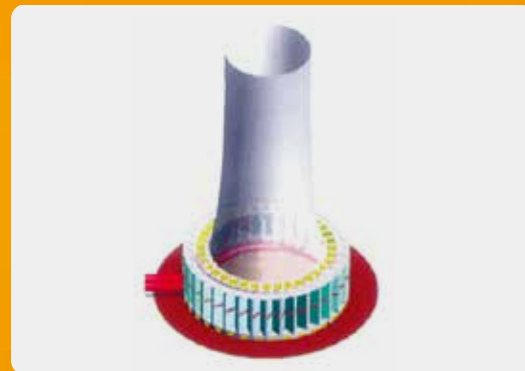

Natural Draft Air Cooled Condenser (NDACC)

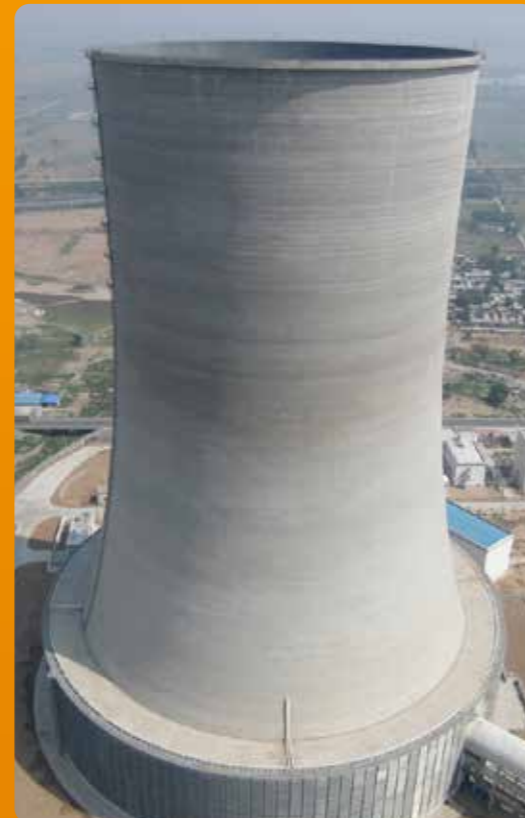

Natural Draft Indirect Dry Cooling Tower (IDCT)



Mechanical Draft Cooling System

# Origin of Dry Cooling Technologies

SEC-SPX's dry cooling technologies originate from Balcke-Dürr and dry cooling sector of Hamon which were acquired by SPX in 2002 and 2003 respectively. Based on the century long history of dry cooling technology research and development by the two brands, SPX now owns more than 250 global patents and is a leader in developing innovative cooling solutions for power stations.

Upon the establishment of SEC-SPX, SPX transfers all its dry cooling technologies and patents into the joint venture. Meanwhile, the joint venture houses an R&D center in Shanghai to be synchronized with the technology advancement developed by SPX's European dry cooling technology center. Thus SEC-SPX is ensured with the latest world-leading technologies to provide products and services to customers in China and globally.

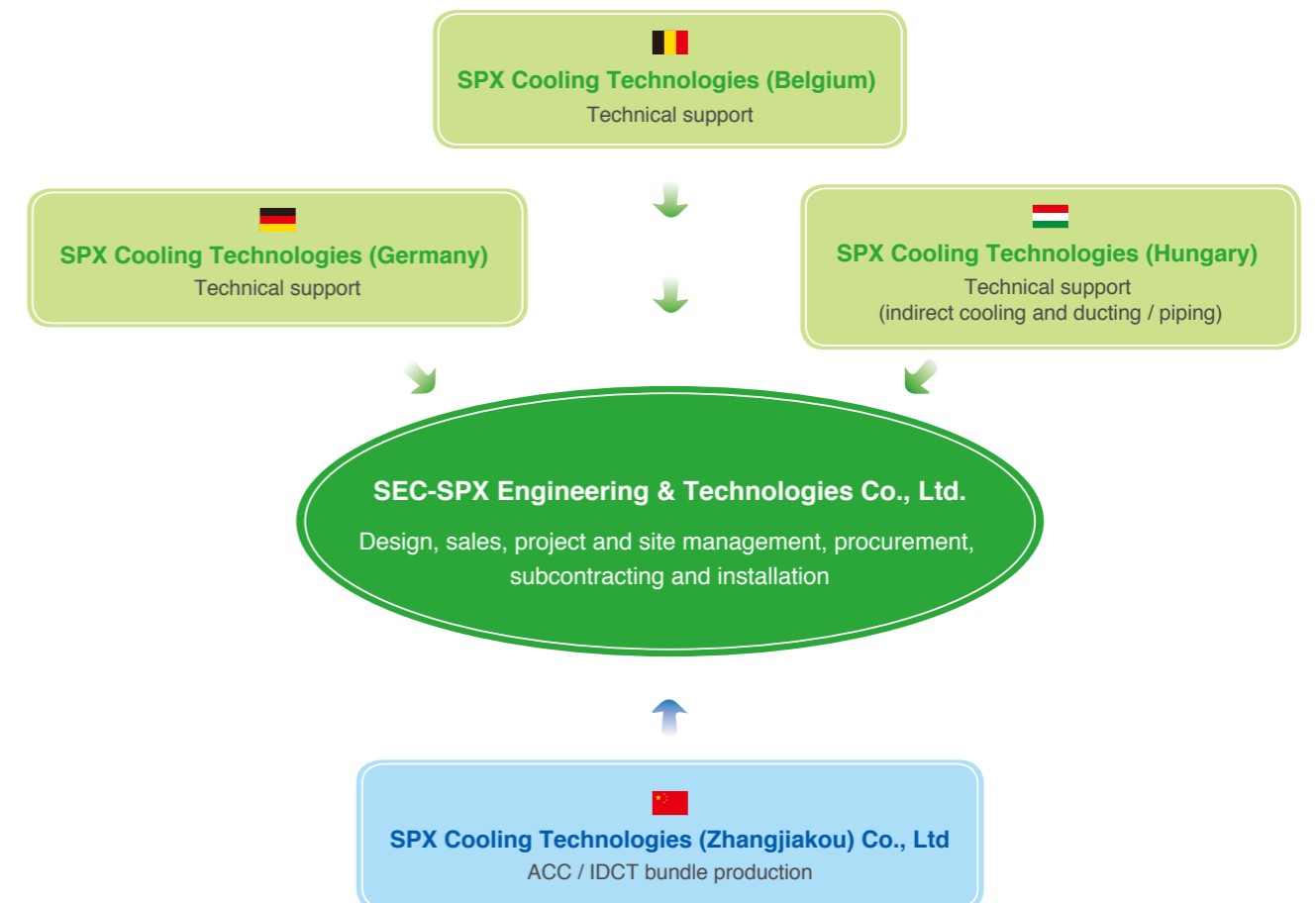

# Mechanical Draft Air Cooled Condenser (ACC)

Air Cooled Condenser (ACC) is a direct dry cooling system where the steam is condensed inside finned tubes, the cooling media air is blowing outside the fin tube. ACC is made of modules arranged in parallel rows. Each module contains a number of fin tube bundles. An axial flow, forced-draft fan located in each module forces the cooling air across the heat exchange area of the fin tubes. The fin tube is the core technology of the ACC, and the quality of fin tube is the key driver for the performance and equipment life time. SPX offers Single-Row Condensers (SRC®) — an elongated, flat tube with brazed aluminium fins.

Mechanical Draft Air Cooled Condenser (ACC) is widely used in all kinds of power plants. SPX was the first to apply single-row fin tube technology in dry cooling and accumulated over 20 years of experience of this technology. Though the single-row fin tube is now a mature technology, SPX continuously develops and innovates and stays in the leading position of this technology. To-date SPX has installed 800 ACCs worldwide.

## Design features of single-row (SRC®)

The fin tube of single-row fin is an elongated flat aluminum coated carbon steel tube with aluminum fins directly brazed on the tube, ensuring an excellent and long lasting thermal and mechanical bonding between the fins and the tubes. Features are the following:

- + High heat exchange efficiency
- + Balanced steam flow ,no risk of backflow with single row technology
- + Robust design in freezing condition
- + Low pressure drop at the steam side, low back pressure
- + Small air side resistance, low power consumption
- + Good cleaning capability

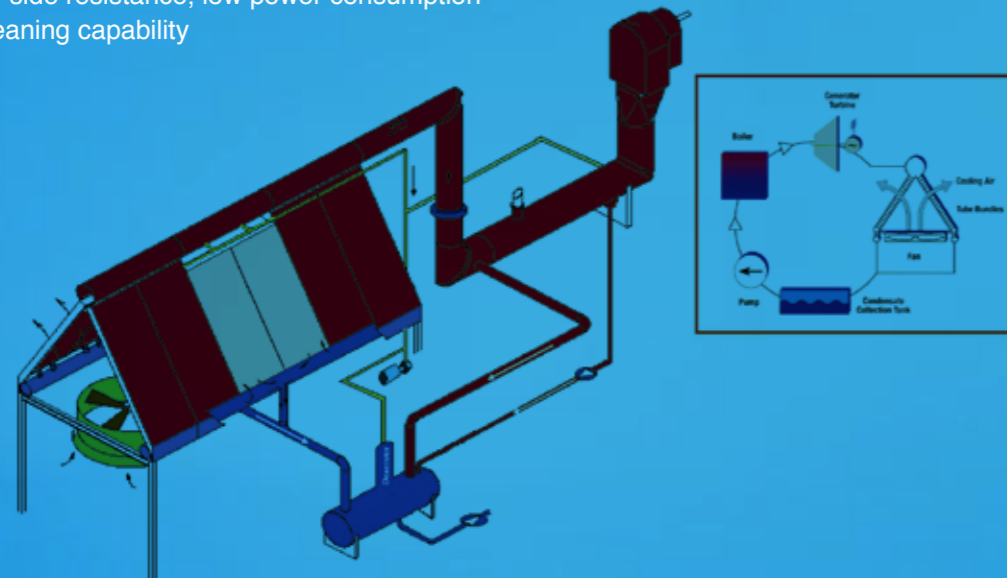

Flow System of Air Cooled Condenser

## Characteristic Technology:ADVANCED ACC

MULTI DELTA technology is upgraded on the basis of traditional mature products. By reducing the “flooding” phenomenon, MULTI DELTA can reduce the freezing risk, control the resistance loss, reduce the back pressure, so as to improve the efficiency of generating units and reduce energy consumption. Moreover, this arrangement also greatly reduces the steel structure assembly on site, so that the installation is more efficient and safe.

## Characteristic Technology:NDC

In natural draft cooling system, the direct dry cooling tube bundles are arranged under the indirect dry cooling tower. The air in the bundles is being cooled with the advantages of indirect and direct dry cooling systems. The technology can directly reduce investment and energy consumption.

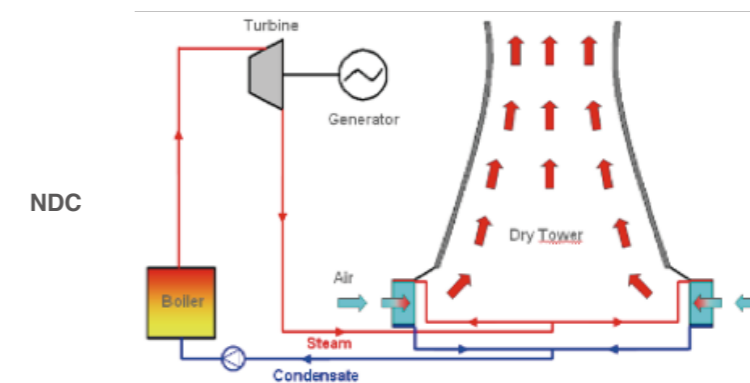

## Advantages of SEC-SPX Air Cooled Condenser:

- + Experienced design team, advanced and rational design plans, excellent manufacture quality
- + High heat exchange efficiency, small resistance, low fan power consumption
- + Low back pressure in winter, energy efficient, increased power generation
- + Good corrosion resistance and anti-freezing performance
- + High adaptability, stable operation, low maintenance cost
- + Reasonably well-designed ducting system, evenly distributed steam
- + Rich experience in designs against strong wind
- + Light, ingenious and stable steel structure
- + Mature technology, competitive price



Inner Mongolia Daihai  
ACC 2x600MW



Shanxi Liulin  
ACC 2x600MW

# Natural Draft Indirect Dry Cooling Tower (IDCT)

Steam flowing from the turbine is condensed by cooling water in either a surface condenser or in a jet condenser. The heated cooling water is then pumped to the heat exchangers arranged vertically around the tower. Airflow across the heat exchangers is created by the natural draft cooling tower.

Indirect dry cooling systems have been used for over 50 years for various applications in the power industry. Active for more than three decades in the indirect dry cooling market, SPX has successfully designed and supplied an indirect dry cooling system for a 6X690MW power plant in South Africa in 1986. The power plant was put into operation in 1992 and is the largest indirect cooling system in operation in the world until present.

## IDCT Products

Fin tube is also the core part of IDCT. With years of research and development, SEC-SPX has designed the most complete portfolio IDCT products on the market at present, including Round Aluminum Tube with Aluminum Fins (RAFT), Multi Channel Tube (MCT) with Steel Tube and Aluminum Fin, Multi Row Condenser (MRC) with Steel Tube and Steel Fin, etc. Among them, the steel tube products have excellent quality and good cleaning effect, and are preferred by a lot of owners despite of their higher prices.

RAFT products are now popular because of the price advantage. RAFT products of SEC-SPX have two ways of arrangement-four rows and six rows, to be designed and manufactured in accordance with the requests of the owners.



Kendal South Africa  
Indirect Dry Cooling System 6X690 MW



Shaanxi Qinling IDCT 2x600MW

## Round Aluminum Tube with Aluminum Fin (RAFT)

In the year 2012, SPX Hungary Technology R&D Center released RAFT tube by adopting the most mature technology in indirect dry cooling market—aluminum tube aluminum fin. RAFT tube has very high heat transfer coefficient and therefore the smallest heat exchange area. Meanwhile, it employs 4-channel double-pass cross-counter flow arrangement, which enjoys the best heat exchange performance, lightweight structure and reduces sensitivity to freezing. In addition, aluminum material provides long term resistance to corrosion.

### RAFT tube features

- + High heat conductivity coefficient. The aluminum fins and tubes adopt high purity aluminum alloy (aluminum content over 99.5%) that has a high heat conductivity coefficient. Consequently the heat exchange area will be smaller under the equivalent design conditions and the clients' investment cost is saved.
- + Very strong resistance to corrosion. The passivation treatment to aluminum product reinforces the air side corrosion resistance. No special protection is required at the air side during operation.
- + High air side heat transfer efficiency. Double bridge type fin structure brings better air side heat transfer performance.
- + High overall strength. The ingenious tube expansion self-locking structure reduces contact loss, enhances heat transfer efficiency, and effectively increases the overall mechanical strength and service life of bundles.
- + State-of-art structure design and manufacturing technologies guarantee reliable connection tightness of bundles.
- + Lightweight tube piece set facilitates transportation and site assembly.
- + Clear fin set is not prone to fouling and is easy to clean.



## Multi Channel Tube (MCT) with Steel Tube and Aluminum Fin

In 2011, the company released indirect cooling MCT tube—steel tube with aluminum fins, similar to direct cooling single-row tube, and it is the best overall performance tube in the indirect dry cooling market at present. The base tube is steel, aluminum coated. Fin is aluminum, with brazing coating. Brazing connection is applied between the base tube and fins. Four tubes form a large flat tube with 4 channels. The four channels are arranged in two passes hence benefitting from the thermal efficiency of the cross-counter flow arrangement.

The patent pending MCT technology is owned by SPX and SEC-SPX exclusively.

### Features of MCT Tube

- + High heat transfer efficiency. Maintaining the advantages of small dead area and small air resistance of ACC single-row flat tube.
- + Stable and reliable performance. Fins and tubes are brazed together, no loss of contact.
- + Outstanding anti-freezing performance. As workshop tests show, the MCT tolerates ice expansion, only deforms but does not break when subject to freezing.
- + Good cleaning performance. Not prone to accumulate dirt or dust between fins and easier to clean than four row tubes in staggered arrangement.
- + Little maintenance. Fully welded structure ensuring no leakage and no frequent maintenance or repair.
- + No additional water treatment. The circulation water side is steel and no electrochemical corrosion will occur.

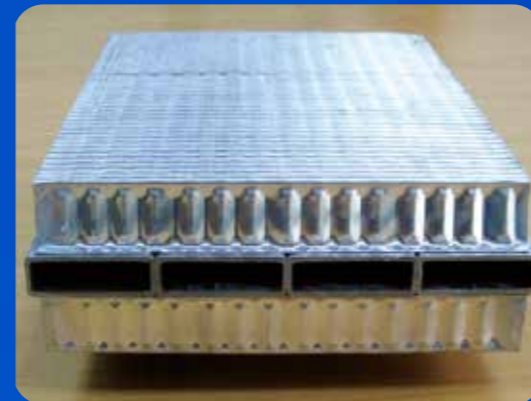

## Steel Tower

The steel tower of SEC-SPX is in the shape of a hyperbola. The special structure and node design can effectively improve the cooling tower stability and aerodynamic performance.

### Comparison between steel tower and concrete tower

|                                  | Steel tower  | Concrete tower |
|----------------------------------|--------------|----------------|
| <b>Total mass (self-weight)</b>  | Low (38%)    | High           |
| <b>Steel quantity</b>            | Equivalent   | Equivalent     |
| <b>High earthquake intensity</b> | Adaptable    | Ordinary       |
| <b>Construction</b>              | Short period | Long period    |
| <b>Disassembly and Recycling</b> | Feasible     | Infeasible     |



# Dry Cooling Manufacturing Bases

SEC-SPX's dry cooling product manufacturing bases locate in Zhangjiakou. These are global manufacturing bases for SPX's dry cooling products fully qualified with required global manufacturing certifications. Experienced technicians, professional management team, good facilities and equipment are the key factors for the plant to supply quality products on time to customers in China and globally.



## Main Clients List



## Project References



Midong Xinjiang  
ACC 2x300MW



Shanxi Wuxiang  
ACC 2x600MW



Inner Mongolia Ewenke  
ACC 2x600MW



Ningxia Daba  
ACC 2x600MW



Inner Mongolia Zhenglan  
ACC 6x600MW



Shanxi Zhongyu Bundles Rebundling  
2x135MW



Kendal South Africa  
Indirect Dry Cooling System 6X690 MW



Shanxi Zuoquan IDCT 2x600MW



Shaanxi Qinling IDCT 2x600MW



Turano Lodigiano  
Sorigenia 800MW combined  
Cycle Power Plant



Hassi R'Mell Algeria ACC for 150MW  
combined Cycle Power Plant Solar  
Power Plant



Goreway Canada 880MW Combined  
Cycle Power Plant

# Typical Achievements

| Project Name            | Capacity (MV) | Products | Place          |
|-------------------------|---------------|----------|----------------|
| National grid Hami      | 660X2         | ACC      | Xinjiang       |
| Dalate IV               | 600x2         | ACC      | Inner Mongolia |
| Zhenglan I              | 600x2         | ACC      | Inner Mongolia |
| Zhenglan II             | 600x2         | ACC      | Inner Mongolia |
| Wuxiang                 | 600x2         | ACC      | Shanxi         |
| Yuncheng                | 600x2         | ACC      | Shanxi         |
| Longshan                | 600x2         | ACC      | Hebei          |
| Fengzhen III            | 600x2         | ACC      | Inner Mongolia |
| Daihai Phase II         | 600x2         | ACC      | Inner Mongolia |
| Liulin                  | 600x2         | ACC      | Shanxi         |
| Fugu                    | 600x2         | ACC      | Shaanxi        |
| Zhangshan II            | 600x2         | ACC      | Shanxi         |
| Baicheng                | 600x2         | ACC      | Inner Mongolia |
| Datang Daba             | 600x2         | ACC      | Ningxia        |
| Huozhou II              | 600x2         | ACC      | Shanxi         |
| Datang Jingtai          | 600x2         | ACC      | Gansu          |
| Hequ II                 | 600x2         | ACC      | Shanxi         |
| Ewenke                  | 600x2         | ACC      | Inner Mongolia |
| Zhenglan III            | 600x2         | ACC      | Inner Mongolia |
| Yuanyanghu              | 600x2         | ACC      | Ningxia        |
| Henglian Wucaiwan       | 600x2         | ACC      | Xinjiang       |
| Gujiao III              | 600x2         | ACC      | Shanxi         |
| Baode                   | 600x2         | ACC      | Shanxi         |
| Pingshuo                | 600x2         | ACC      | Shanxi         |
| Tianshan Power          | 350x2         | ACC      | Xinjiang       |
| Mengtai                 | 330X4         | ACC      | Inner Mongolia |
| Baota                   | 350X2         | ACC      | Xinjiang       |
| Yanggao                 | 350X2         | ACC      | Shanxi         |
| Tianye                  | 330X2         | ACC      | Xinjiang       |
| Zhangshan I             | 300x2         | ACC      | Shanxi         |
| Yushe                   | 300x2         | ACC      | Shanxi         |
| Gujiao I                | 300x2         | ACC      | Shanxi         |
| Hejin I                 | 300x2         | ACC      | Shanxi         |
| Huozhou I               | 300x2         | ACC      | Shanxi         |
| Pingshuo II             | 300x2         | ACC      | Shanxi         |
| Xin'an Aluminum         | 300x2         | ACC      | Henan          |
| Linfen                  | 300x2         | ACC      | Shanxi         |
| Baotou II               | 300x2         | ACC      | Inner Mongolia |
| Mengxi                  | 300x2         | ACC      | Inner Mongolia |
| Yongji I                | 300x2         | ACC      | Shanxi         |
| Lanzhou Aluminum        | 300x3         | ACC      | Gansu          |
| Gangu                   | 300x2         | ACC      | Gansu          |
| Baotou I                | 300x2         | ACC      | Inner Mongolia |
| Midong                  | 300x2         | ACC      | Xinjiang       |
| Salaqi                  | 300x2         | ACC      | Inner Mongolia |
| Jincheng Thermal        | 300x2         | ACC      | Shanxi         |
| Zhongmei Wucaiwan       | 660x2         | IDCT     | Xinjiang       |
| ZhaoZhuang              | 660x2         | IDCT     | Shanxi         |
| Zhundong Wucaiwan       | 660x2         | IDCT     | Xinjiang       |
| Xinjiang Ruihong        | 660x2         | IDCT     | Xinjiang       |
| Qinling                 | 600x2         | IDCT     | Shaanxi        |
| Zuoquan                 | 600x2         | IDCT     | Shanxi         |
| Yangling                | 350X2         | IDCT     | Shaanxi        |
| Jiexiu                  | 350X2         | IDCT     | Shanxi         |
| Lingshi Qiguang         | 350X2         | IDCT     | Shanxi         |
| Shanxi Guoxjin          | 350X2         | IDCT     | Shanxi         |
| Inner Mongolia Junzheng | 330x2         | IDCT     | Inner Mongolia |
| Wu'an                   | 300x2         | IDCT     | Hebei          |

# China Achievements (Till 2016.03)

Total:88

